

GENERAL DESCRIPTION

LED luminaire for surface mounting for ceiling or wall.
As standard #12 clear prismatic acrylic wrap-around lens. With rigid body constructed from code gauge steel and spring-loaded and hinged end caps. Spring-loaded and hinged end caps make installation easy. Ideal for stairwells and other commercial environments. Row mounting available, consult factory.

CERTIFICATION

Approved to UL1598 and CSA C22.2 No. 250 standards**
Suitable for damp locations.



*LED Five (5) year limited warranty.
**Operating temperature: -20°C to +35°C / -4°F to +95 °F, consult factory for operating temperatures outside the listed range.
Specifications are subject to change. Please confirm latest specifications prior to placing order.

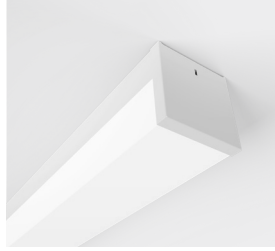

PERFORMANCE SUMMARY 8FT X 4FT AT 4000K

LUMENS(lm)	WATTAGE(W)	EFFICACY(lm/W)
4200	40	105

PERFORMANCE SUMMARY 8FT X 8FT AT 4000K

LUMENS(lm)	WATTAGE(W)	EFFICACY(lm/W)
8400	80	105

PERFORMANCE SUMMARY 12FT AT 4000K

LUMENS(lm)	WATTAGE(W)	EFFICACY(lm/W)
6000	55	109

PHOTOMETRIC DATA

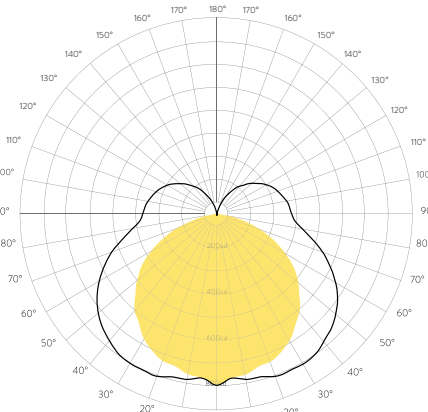

CI-4-40-40K

0°-180° ■
90°-270° ■

DIMENSIONS

SIZE	L	W	H
2FT	24.00"	4.50"	4.50"
3FT	36.00"	4.50"	4.50"
4FT	48.00"	4.50"	4.50"

MOUNTING / CROSS SECTION

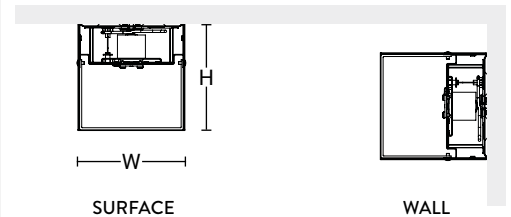

ORDERING INFORMATION

CI	FIXTURE	LENGTH	LUMENS	CCT	SHIELDING	FINISH	CONTROLS *OPTIONAL*	DRIVER
CI = CI. Wrap-Around Lens	2 = 2ft	25 = 2500lm	30K = 3000K	TW = Tunable White	C = #12 Clear Prismatic Acrylic O = Opal White Acrylic	GLOSSY W = White Housing B = Black Housing G = Grey Housing MATTE WM = White Housing BM = Black Housing GM = Grey Housing X = other colours and finishes available, consult factory	OC = On/Off Occupancy Control O5 = 100%-50% Hi/Low Occupancy Control	MV = Standard 120V-277V 1% Dimming (0-10V) 347 = Standard 347V Dimming (0-10V) EM = Emergency Driver X = DALI, Lutron EcoSystem LED, and other drivers available, consult factory
			35K = 3500K					
			40K = 4000K					
		3 = 3ft	28 = 2800lm					
			32 = 3200lm					
			36 = 3600lm					
	4 = 4ft	32 = 3200lm						
		36 = 3600lm						
		40 = 4000lm						
				44 = 4400lm				
				50 = 5000lm				



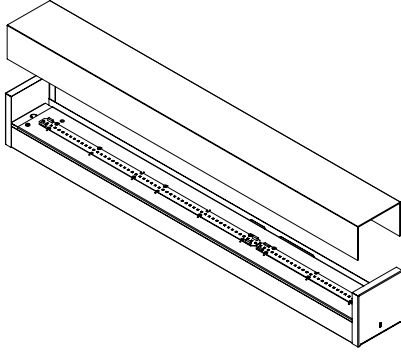

DIMENSIONS

SIZE	L	W	H	MTG L	MTG W
2FT	24.00"	4.50"	4.50"	16.65"	1.90"
3FT	36.00"	4.50"	4.50"	28.05"	1.90"
4FT	48.00"	4.50"	4.50"	39.50"	1.90"

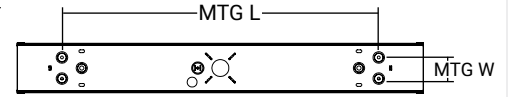
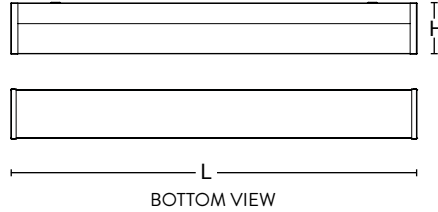

SHIELDING

As standard #12 clear prismatic acrylic wrap-around lens.
Opal white acrylic lens option available.

CONSTRUCTION

Rigid body constructed from code gauge steel
with spring-loaded and hinged end caps.

FINISH

Standard finish is high gloss white polyester baked powder
coat enamel. Custom colours available, consult factory.
Glossy / Matte / Custom Colours



LED LIGHT ENGINE

Mounted on internal high reflectance white painted
reflector.

LED DRIVER

1% Dimming (0-10V). Emergency driver available.
DALI (Digital Addressable Lighting Interface), Lutron
EcoSystem LED, and other drivers available, consult
factory.

ELECTRICAL

3000K 3500K 4000K

120V - 277V 347V

*TW (Tunable White), other CCT, RGB (Red, Green, Blue
LEDs), DM (dim to warm) available, consult factory.
L80 performance at 60,000 hours minimum.
80 CRI Standard. Other dimming options, lumen options,
90CRI and lengths available, consult factory.

CERTIFICATION

Approved to UL1598 and CSA C22.2 No. 250 standards**
Suitable for damp locations.



*LED Five (5) year limited warranty.

**Operating temperature: -20°C to +35°C / -4°F to +95 °F, consult factory
for operating temperatures outside the listed range.

MOUNTING / CROSS SECTION

Surface mounting for ceiling or wall.

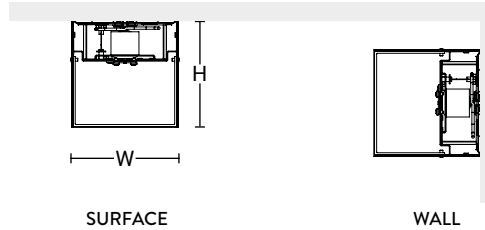

PHOTOMETRIC DATA

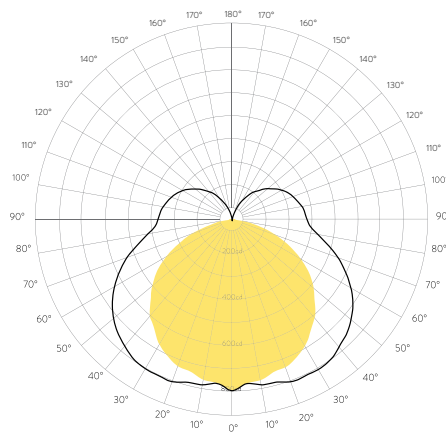

CI-4-40-40K

0°-180° █
90°-270° █

ZONAL LUMEN SUMMARY

Zone	Lumens
0.00°-10.00°	88.95
10.00°-20.00	217.58
20.00°-30.00	347.49
30.00°-40.00	445.50
40.00°-50.00	496.49
50.00°-60.00	469.79
60.00°-70.00	438.43
70.00°-80.00	339.29
80.00°-90.00	252.03
90.00°-100.00	217.05
100.00°-110.00	199.01
110.00°-120.00	170.00
120.00°-130.00	132.97
130.00°-140.00	92.87
140.00°-150.00	55.91
150.00°-160.00	25.35
160.00°-170.00	7.15
170.00°-180.00	0.66
0.00°-90.00	3122.54
90.00°-180.00	900.97
0.00°-180.00	4023.51

CONE OF LIGHT

Mtg Height	Light Level	Beam Diameter
6.0 ft	22.1 fc	41.0 ft
8.0 ft	12.5 fc	54.7 ft
10.0 ft	8.0 fc	68.4 ft
12.0 ft	5.5 fc	82.0 ft
15.0 ft	3.5 fc	102.6 ft

AVERAGE LUMINAIRE LUMINANCE (CD/M2)

	0.00°	45.00°	90.00°
0.00°	5617	5617	5617
45.00°	4731	3685	3654
55.00°	4486	3354	3352
65.00°	3860	2906	2966
75.00°	2842	2378	2563
85.00°	1642	2036	2298



CI . Wrap-Around Lens

PROJECT:
CAT.NO:
NOTES:

DATE:
TYPE:
VOLTS:

PEERLUX®
SERIES

WATTAGE & EFFICACY - 2FT

CI-2-25-30K	2500lm	3000K	27W	94lm/W
CI-2-25-35K	2500lm	3500K	26W	97lm/W
CI-2-25-40K	2500lm	4000K	25W	100lm/W

WATTAGE & EFFICACY - 3FT

CI-3-28-30K	2800lm	3000K	29W	99lm/W
CI-3-28-35K	2800lm	3500K	27W	101lm/W
CI-3-28-40K	2800lm	4000K	27W	105lm/W
CI-3-32-30K	3200lm	3000K	33W	98lm/W
CI-3-32-35K	3200lm	3500K	33W	99lm/W
CI-3-32-40K	3200lm	4000K	31W	104lm/W
CI-3-36-30K	3600lm	3000K	37W	97lm/W
CI-3-36-35K	3600lm	3500K	37W	99lm/W
CI-3-36-40K	3600lm	4000K	35W	103lm/W

WATTAGE & EFFICACY - 4FT

CI-4-32-30K	3200lm	3000K	30W	106lm/W
CI-4-32-35K	3200lm	3500K	30W	108lm/W
CI-4-32-40K	3200lm	4000K	29W	112lm/W
CI-4-36-30K	3600lm	3000K	34W	105lm/W
CI-4-36-35K	3600lm	3500K	34W	106lm/W
CI-4-36-40K	3600lm	4000K	32W	111lm/W
CI-4-40-30K	4000lm	3000K	39W	104lm/W
CI-4-40-35K	4000lm	3500K	38W	106lm/W
CI-4-40-40K	4000lm	4000K	37W	110lm/W
CI-4-44-30K	4400lm	3000K	43W	103lm/W
CI-4-44-35K	4400lm	3500K	43W	105lm/W
CI-4-44-40K	4400lm	4000K	41W	108lm/W
CI-4-50-30K	5000lm	3000K	51W	98lm/W
CI-4-50-35K	5000lm	3500K	50W	100lm/W
CI-4-50-40K	5000lm	4000K	48W	105lm/W